

MED8P62 is a low failure infrared point source LED die with wide space between the small size emitting aperture and the electrode pad. It is available to mount on ball lens directly.

### Features

- Small-size emitting aperture ( $\phi 60\mu\text{m}$ )
- High output power
- High reliability

### Structure

- Material: AlGaAs/GaAs sub.
- Electrode: Au alloy (p,n)
- Emitting surface: p-side

### Applications

- Optical encoders
- Optical switches
- Optical sensors etc

### Dimensional outline drawing ( $\mu\text{m}$ )

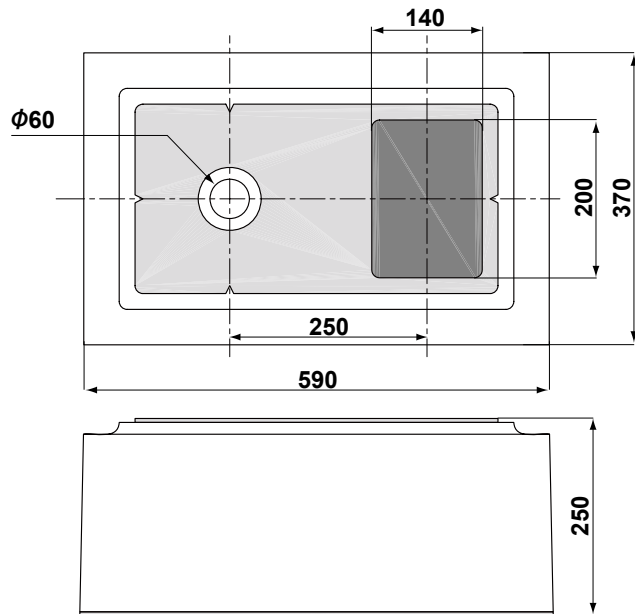

### Absolute Maximum Ratings\* ( $T_a=25^\circ\text{C}$ )

Parameter	Symbol	Rating	Unit
Forward Current	$I_F$	80	mA
Reverse Voltage	$V_R$	3	V
Operating Temperature	$T_{opr}$	-20~80	$^\circ\text{C}$
Storage Temperature	$T_{stg}$	-30~100	$^\circ\text{C}$

### Electro-Optical Characteristics\* ( $T_a=25^\circ\text{C}$ )

Parameter	Symbol	Condition	Min.	Typ.	Max.	Unit
Forward Voltage	$V_F$	$I_F=50\text{mA}$	-	2.0	2.4	V
Reverse Current	$I_R$	$V_R=3\text{V}$	-	-	10	$\mu\text{A}$
Output Power	$P_o$	$I_F=50\text{mA}$	1.2	2.0	-	mW
Central Wavelength	$\lambda_c$	$I_F=50\text{mA}$	-	855	-	nm
Cutoff Frequency	$f_c$	$I_F=50\text{mA}+20\text{mA}_{p-p}$	-	45	-	MHz

\*As mounted on T018 header and hermetically sealed

Fig1.  $I_F / T_a$

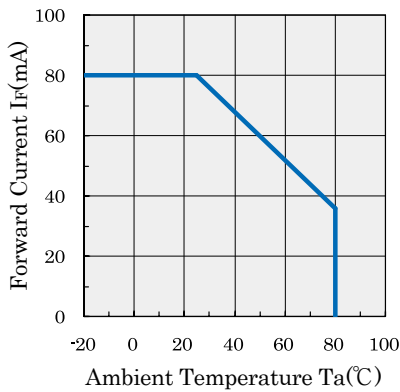

Fig2.  $I_F / V_F$

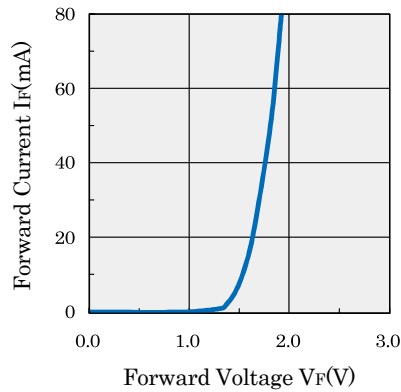

Fig3.  $V_F / T_a$

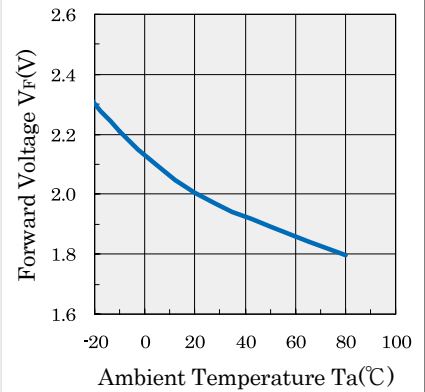

Fig4.  $P_O / I_F$

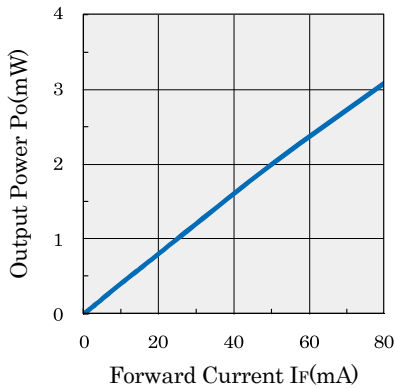

Fig5. Relative  $P_O / T_a$

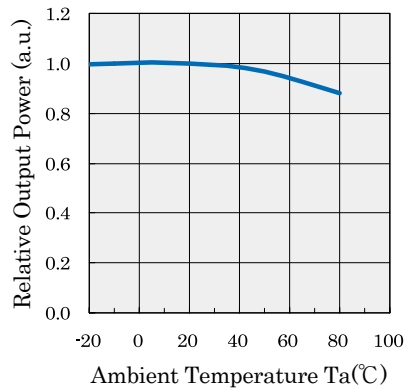

Fig6. Frequency Response

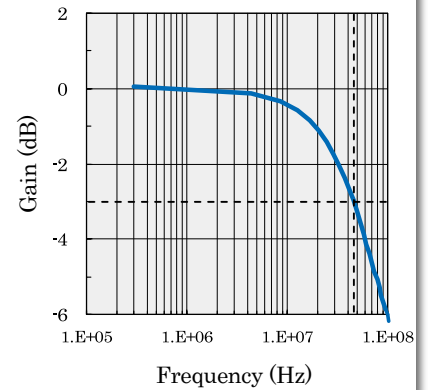

Fig7. Spectral Characteristics

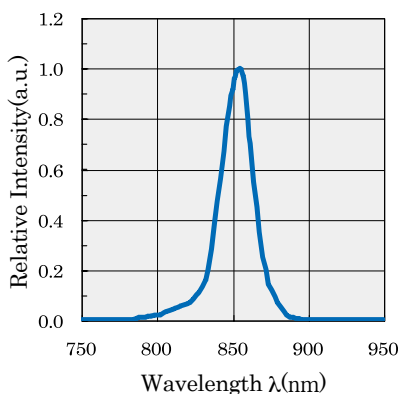

Fig8. Central Wavelength  $\lambda_c / T_a$

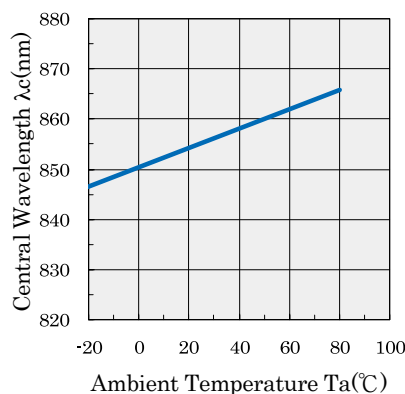
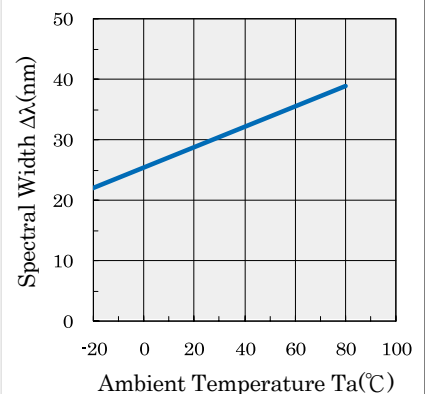

Fig9. Spectral Width  $\Delta\lambda / T_a$



This catalogue was compiled in March 2023. All items listed in the catalogue are subject to change without any prior notice.

Products listed in this catalogue are designed and manufactured for use in standard applications (eg: household appliances, OA/AV, telecommunications, measurement instruments). The customers should take security measures, when used the products in critical reliability and security applications (eg: space and aviation, critical-safety transport applications, nuclear power control, medical, life-supporting units and equipment). We assume no liability for damages incurred by use of the products without taking measures described above.

