

MED7P14C is an AlInGaP red point source LED with a small emitting window. This die is ideally suited for use in applications where high and parallel output power is required such as optical switches and sensors.

## Features

- Small emitting window ( $\phi 160\mu\text{m}$ )
- High output power
- High reliability

## Structure

- Material: AlInGaP/Si
- Electrode: Au alloys (n,p)
- Emitting surface: n-side

## Applications

- Optical sensors
- Optical switches

## Dimensional outline drawing( $\mu\text{m}$ )

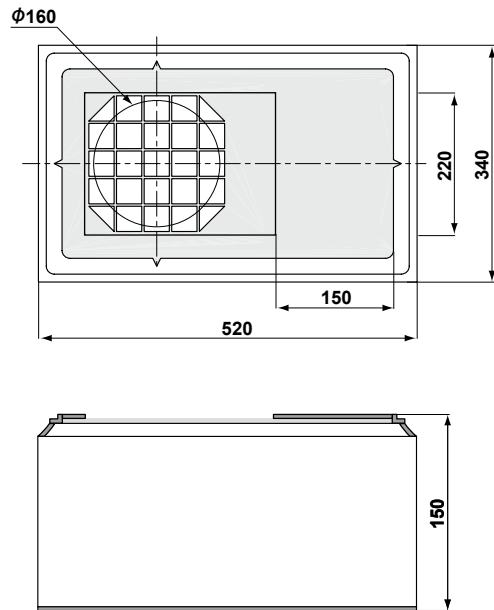

## Absolute Maximum Ratings\* ( $T_a=25^\circ\text{C}$ )

Parameter	Symbol	Rating	Unit
Forward Current	$I_F$	50	mA
Reverse Voltage	$V_R$	3	V
Operating Temperature	$T_{opr}$	-40~85	$^\circ\text{C}$
Storage Temperature	$T_{stg}$	-40~100	$^\circ\text{C}$

## Electro-Optical Characteristics\* ( $T_a=25^\circ\text{C}$ )

Parameter	Symbol	Condition	Min.	Typ.	Max.	Unit
Forward Voltage	$V_F$	$I_F=20\text{mA}$	-	2.1	2.8	V
Reverse Current	$I_R$	$V_R=3\text{V}$	-	-	10	$\mu\text{A}$
Output Power	$P_o$	$I_F=20\text{mA}$	1.4	2.0	-	mW
Peak Wavelength	$\lambda_p$	$I_F=20\text{mA}$	-	650	-	nm

\*As mounted on T018 header and hermetically sealed.

Fig.1  $I_F / T_a$

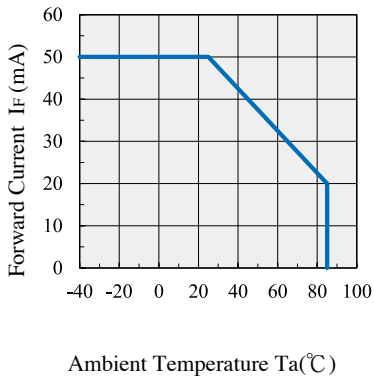

Fig.2  $I_F / V_F$

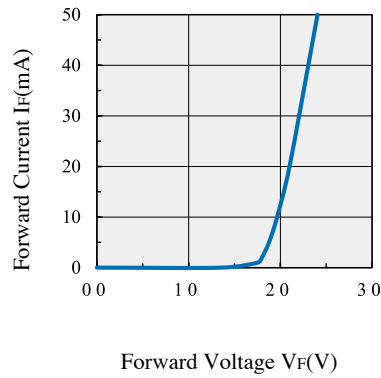

Fig.3  $V_F / T_a$

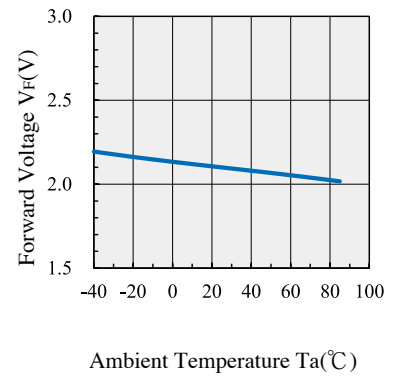

Fig.4  $P_o / I_F$

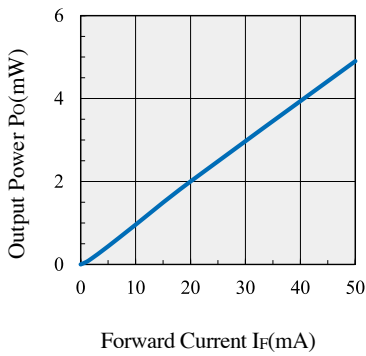

Fig.5 Relative  $P_o / T_a$

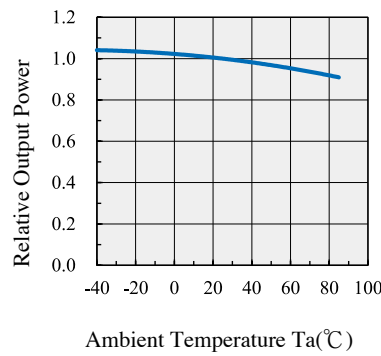

Fig.6 Frequency Response

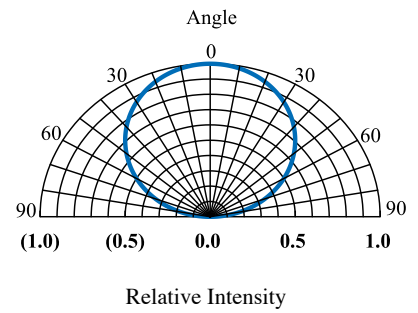

Fig.7 Spectral Characteristics

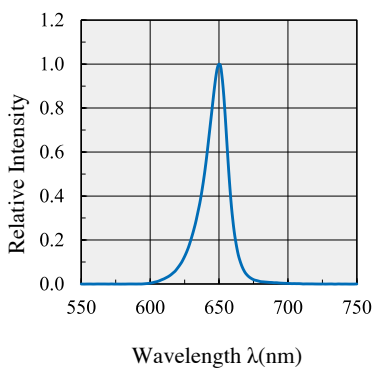

Fig.8 Central Wavelength  $\lambda_p / T_a$

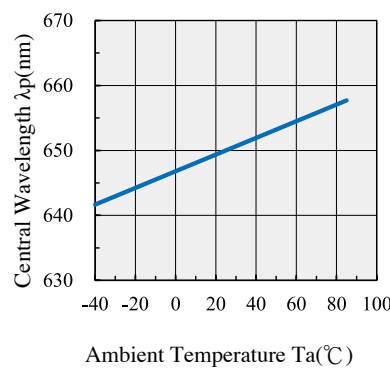
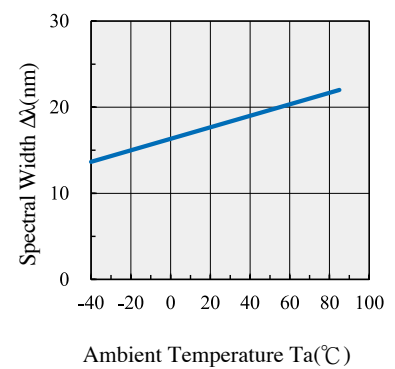

Fig.9 Spectral Width  $\Delta\lambda / T_a$



This catalogue was compiled in September 2024. All items listed in the catalogue are subject to change without any prior notice.

Products listed in this catalogue are designed and manufactured for use in standard applications (eg: household appliances, OA/AV, telecommunications, measurement instruments). The customers should take security measures, when used the products in critical reliability and security applications (eg: space and aviation, critical-safety transport applications, nuclear power control, medical, life-supporting units and equipment). We assume no liability for damages incurred by use of the products without taking measures described above.

